

COMMENTS / NOTES

MACPANEL

WWW.MACPANEL.COM

DRAWN BY  
davecooper

DATE  
02/02/2024



Third Angle  
Projection

DESCRIPTION

Wireless ITA PCB SCOUT

DRAWING NO.

-CU

REVISION

C

SHEET  
1 OF 4

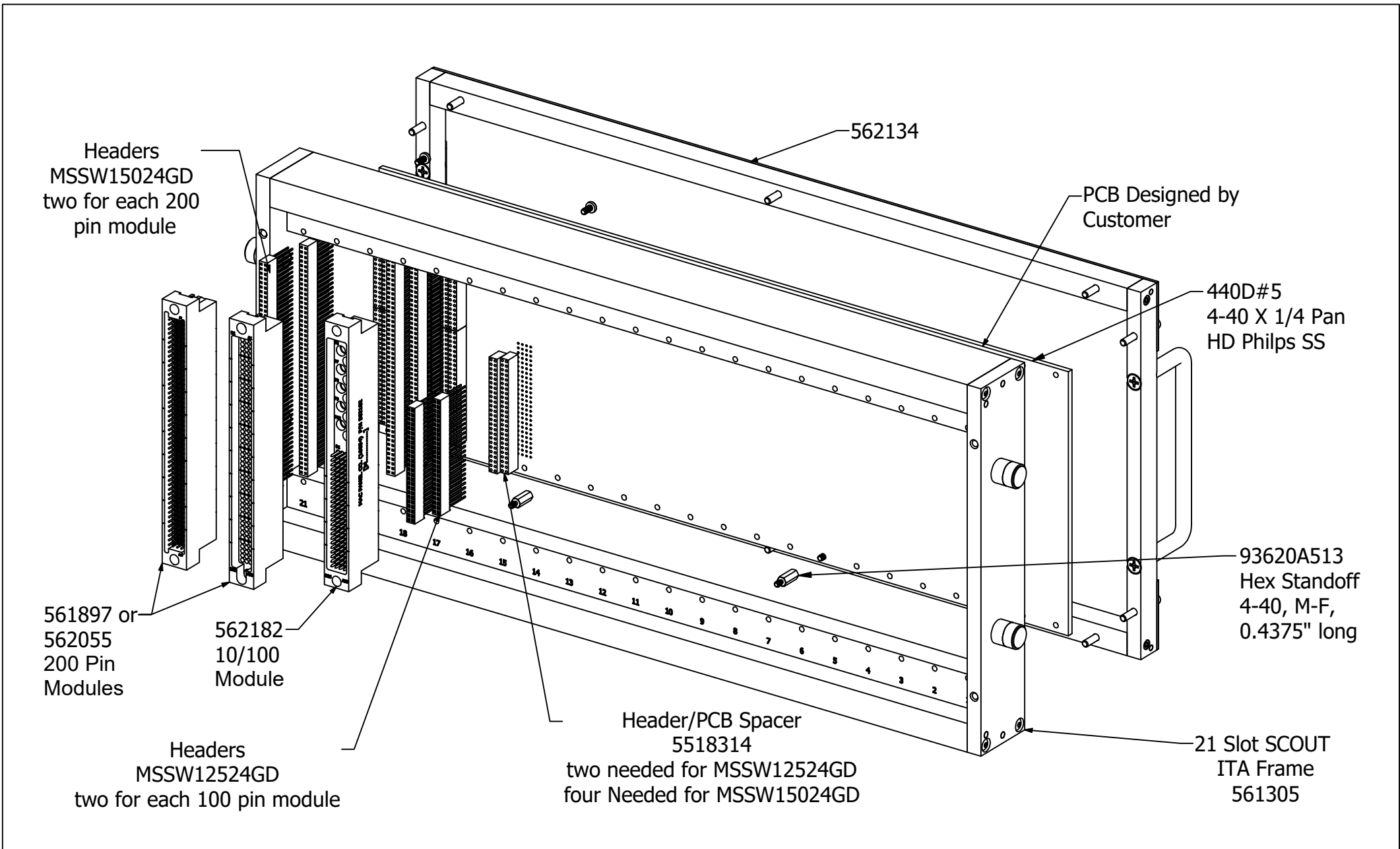

COMMENTS / NOTES 1off 93620A512 Standoff and 1off 440D#5 screw can be bought as "5210143-Kit"			DRAWN BY davecooper	DATE 02/02/2024	DESCRIPTION Wireless ITA PCB SCOUT
	WWW.MACPANEL.COM		Third Angle Projection		DRAWING NO. -CU
			SHEET 2 OF 4	REVISION C	

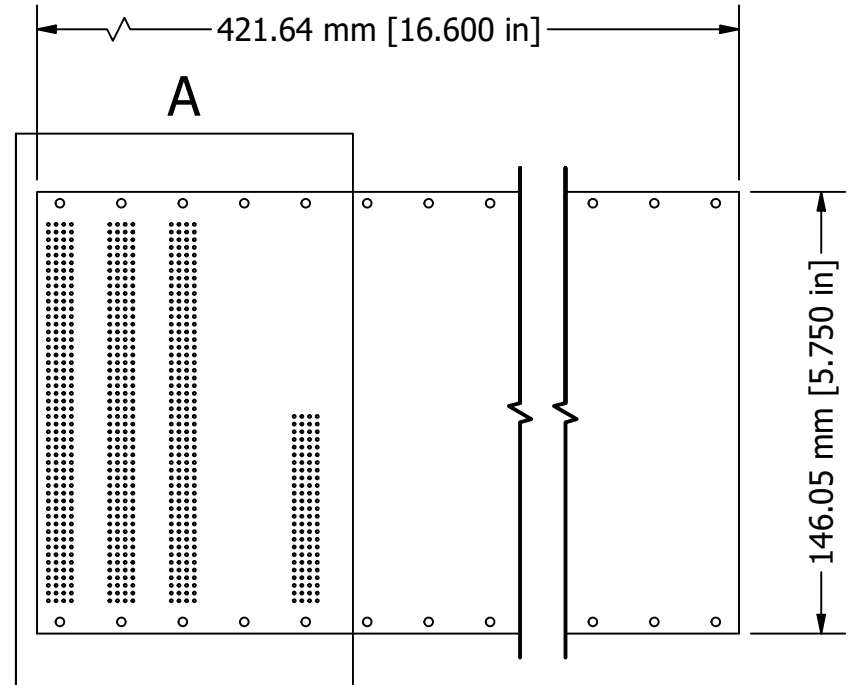
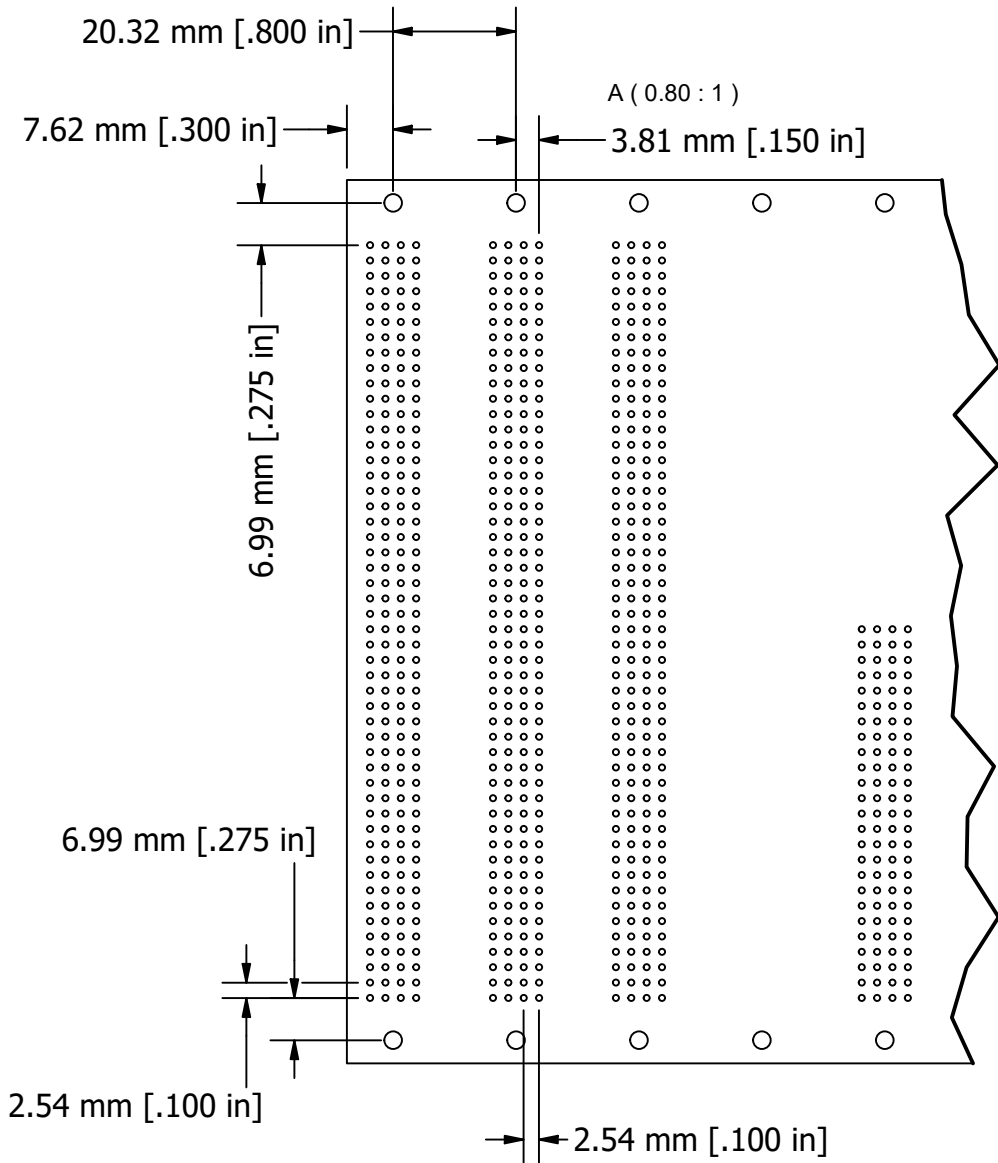

COMMENTS / NOTES

MAC-PANEL

WWW.MACPANEL.COM

DRAWN BY  
davecooper

DATE  
02/02/2024

DESCRIPTION

Example\_PCB\_SCOUT\_A

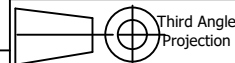

DRAWING NO.

example\_PCB\_SCOUT\_A-CU

REVISION

SHEET  
3 OF 4

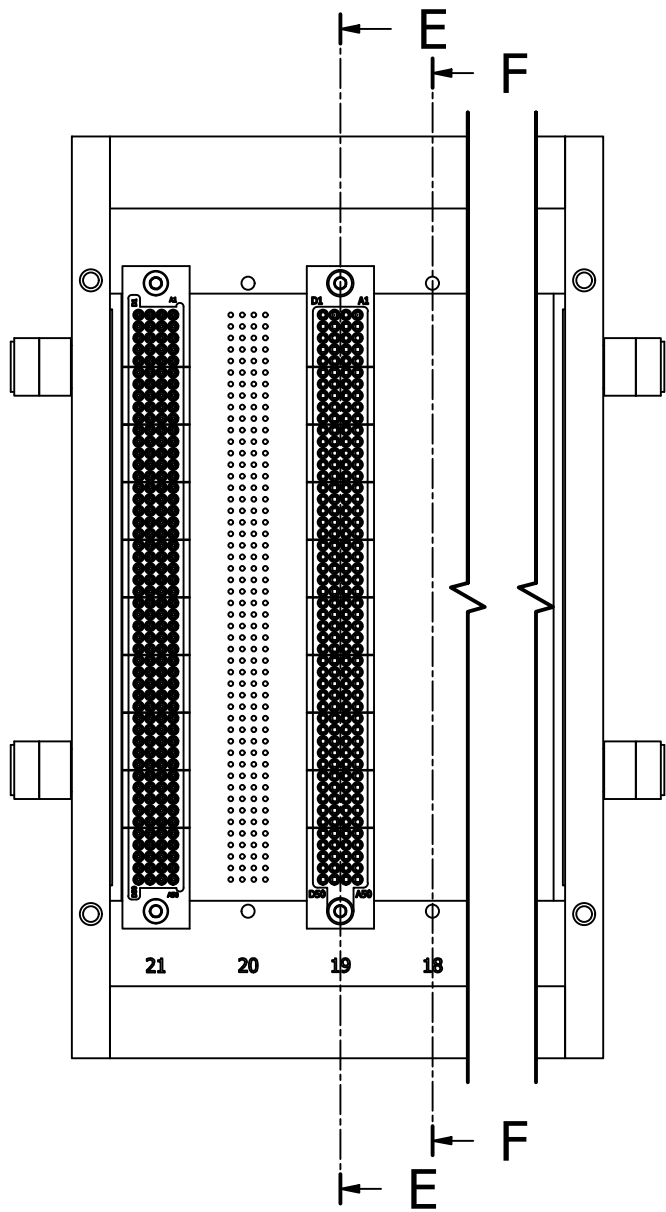

E-E (0.6)

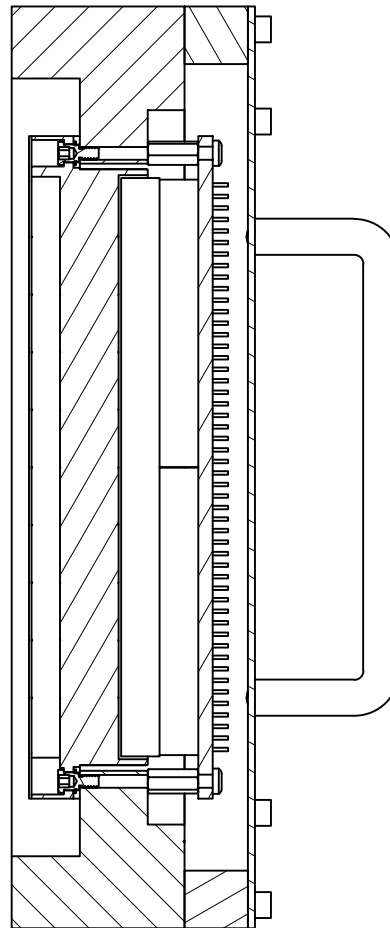

F-F (0.6)

1.52 mm [.060 in]

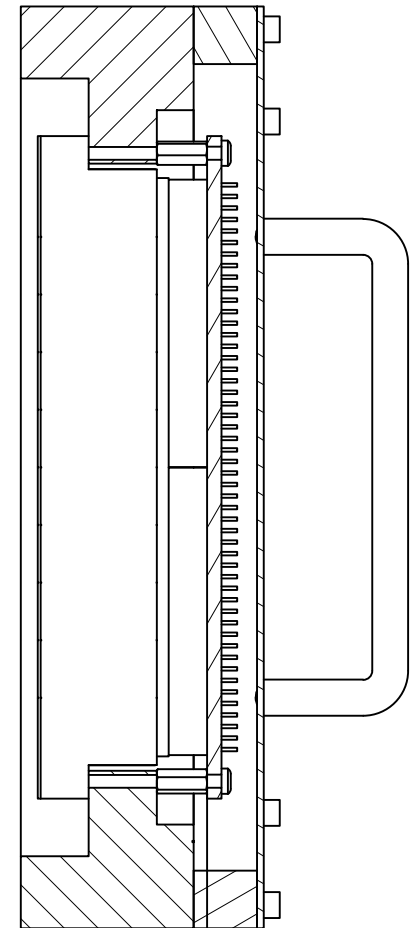

10.99 mm [.433 in]

COMMENTS / NOTES

MAC-PANEL

WWW.MACPANEL.COM

DRAWN BY  
davecooper

DATE  
02/02/2024

DESCRIPTION

Wireless ITA PCB SCOUT

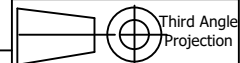

DRAWING NO.

-CU

REVISION

C

SHEET  
4 OF 4