

Crimp Tool Assembly.

Step 1

From the "Crimp Information" table below, select the correct Crimp Tool and Hex Die for the contact you are using.

Crimp Information						
Contact P/N	Wire Type	Crimp Tool	Hex Die	Letter in view	Large Crimp	Small Crimp
0884010-07	DBL SHLD RG316	452300	452309	R	A	B
0884010-08	RG178 (SPCL)	452300	452312	R	A	C
0884010-10	RG178	452300	452312	R	A	C
0884010-11	RG316	452300	452312	R	A	B
0884010-12 (legacy)	RG179	452300	452312	R	A	B
0884010-13	JOY-14	452300	452309	R	A	C
0884010-14	101R	452300	452312	R	A	B
7861200-10	RG178	452300	452312	R	A	C
7861200-11	RG316	452300	452312	R	A	B

Step 2

Attach the Hex Die to the Crimp Tool with the appropriate "letter in view" on the top face.

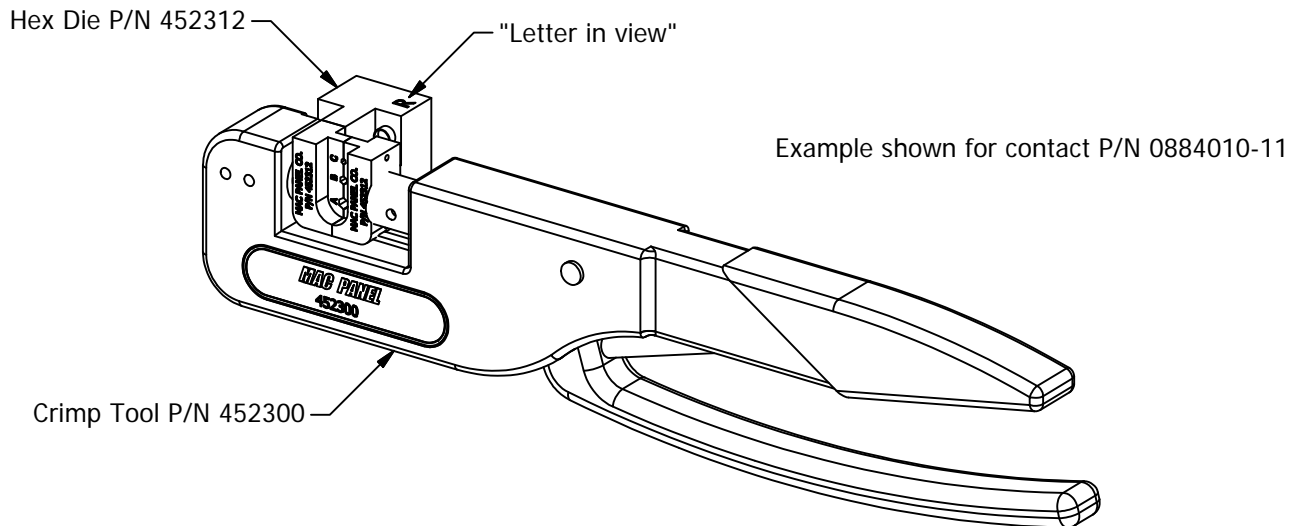

The crimp tool will automatically re-open the hex die when the handles are fully closed.

Your crimp tool is now ready to crimp the contacts when they have been assembled.

See the following page for the correct contact assembly procedure.

Contact Assembly Procedure.

1) Using appropriate tooling for your cable type, Strip one end to the dimensions shown below.

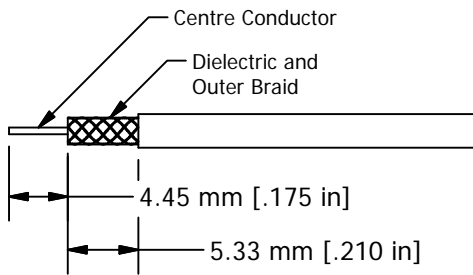

2) Slide crimp ring over stripped end, Pull outer braiding back over cable covering.
** Braid must be equally and completely distributed over the cable covering **

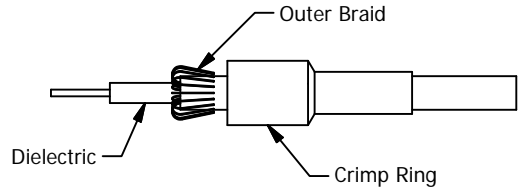

3) Where applicable, slide the teflon tube over the Dielectric. Solder the centre conductor into the contact centre pin.
** After cooling test joint with a gentle pull **

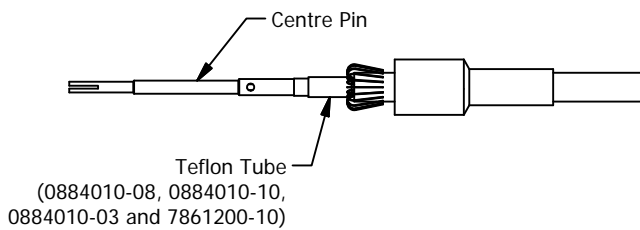

4) Ensure Contact Dielectric is pushed firmly into the contact outer shield.

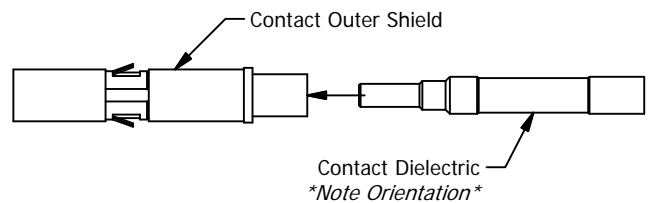

5) Push the centre pin and cable assembly fully inside the contact dielectric.

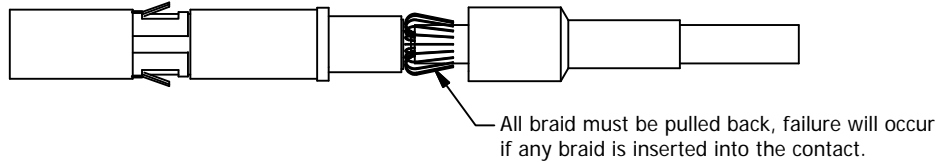

6) Ensure outer cable braid is folded evenly around circumference of the contact body.

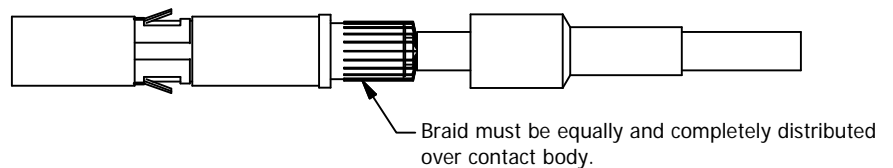

7) Push crimp ring over contact body and crimp large and small crimp zones using A, B or C part of Hex Die. Correct letters for the contact you are using can be found in the "Crimp Information" table on sheet 1.

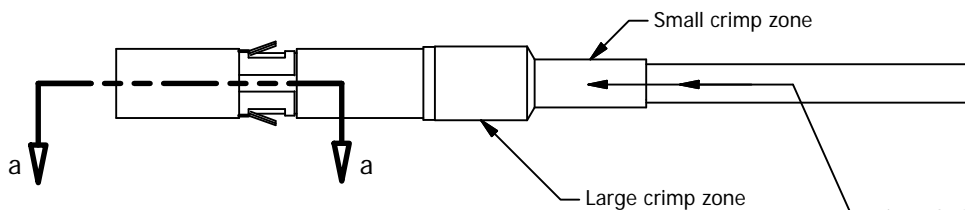

$1.52 \pm .51 \text{ mm} [.060 \pm .020 \text{ in}]$

Is the distance the centre pin should be below the front face of the contact if it has been assembled correctly.

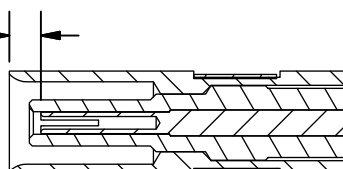

SECTION a-a

** Apply forward pressure to both crimp ring & cable during the crimping process to ensure the center pin remains properly seated. **