

COMMENTS / NOTES
Overall View

MAC-PANEL

WWW.MACPANEL.COM

DRAWN BY
davecooper

DATE
16/04/2015

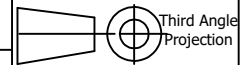

DESCRIPTION
Enclosure, ITA, JSF, EMI Shielded

SHEET
1 OF 5

DRAWING NO.
08701300-04-CU

REVISION
H

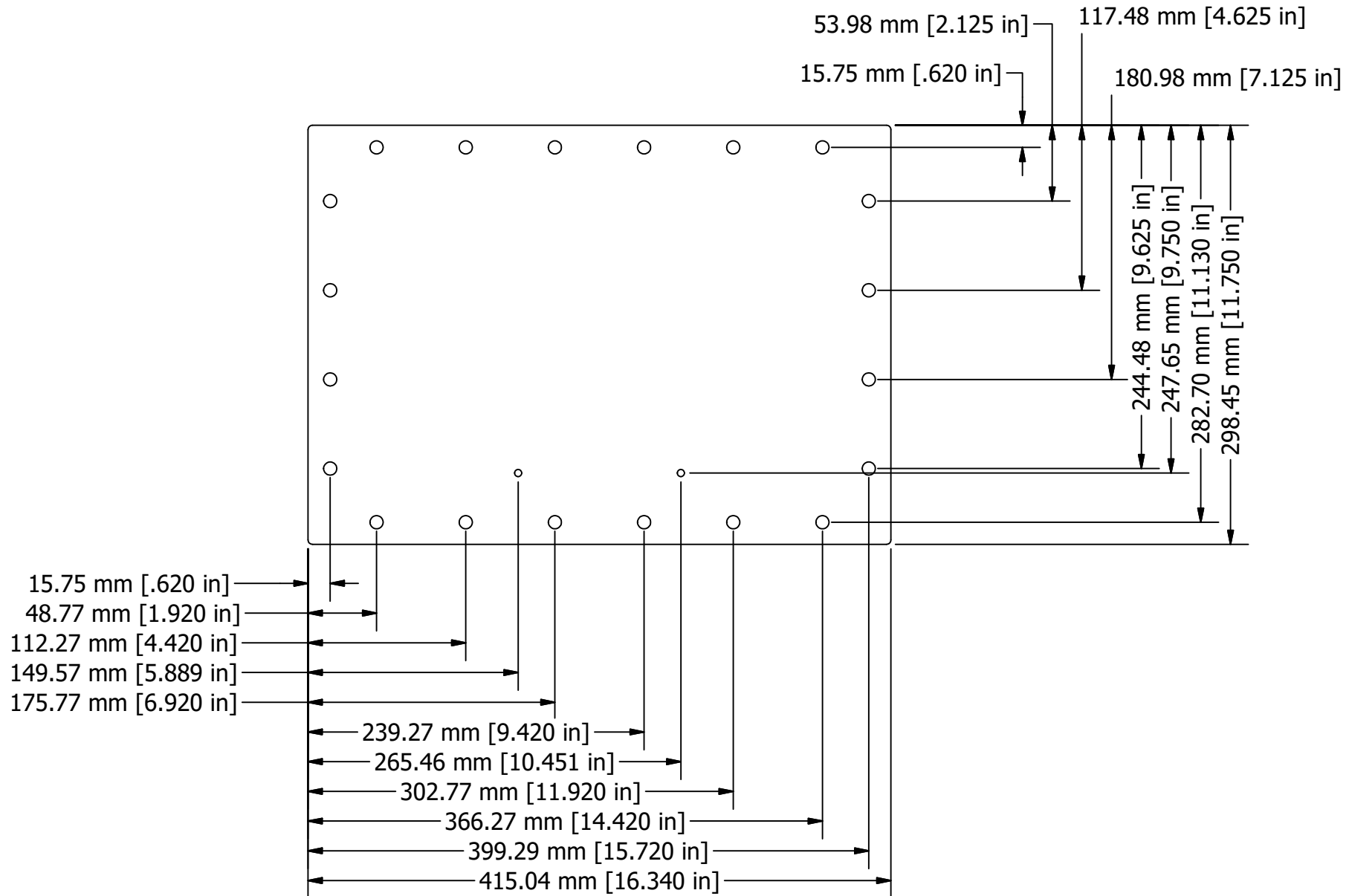

COMMENTS / NOTES

Top Panel
(Same for Bottom Panel without holes for Handle)

MAC-PANEL

WWW.MACPANEL.COM

DRAWN BY
davecooper

DATE
16/04/2015

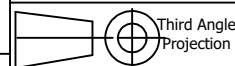

DESCRIPTION

Enclosure, ITA, JSF, EMI Shielded

SHEET
2 OF 5

DRAWING NO.

08701300TP14-CU

REVISION

H

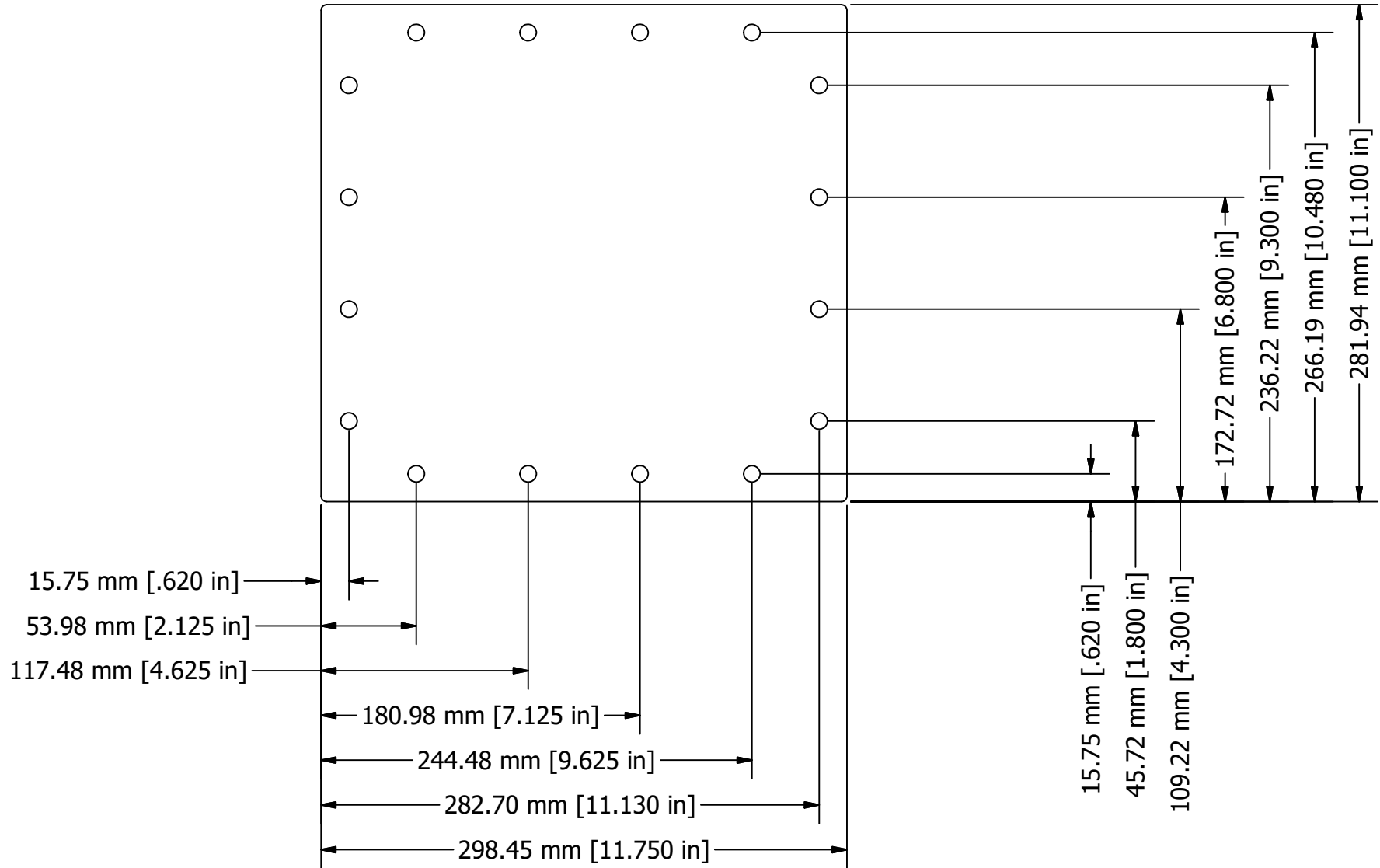

COMMENTS / NOTES

Side Panels

MAC-PANEL

WWW.MACPANEL.COM

DRAWN BY
davecooper

DATE
16/04/2015

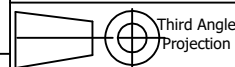

SHEET
3 OF 5

DESCRIPTION

Enclosure, ITA, JSF, EMI Shielded

DRAWING NO.

08701300SP14-CU

REVISION

H

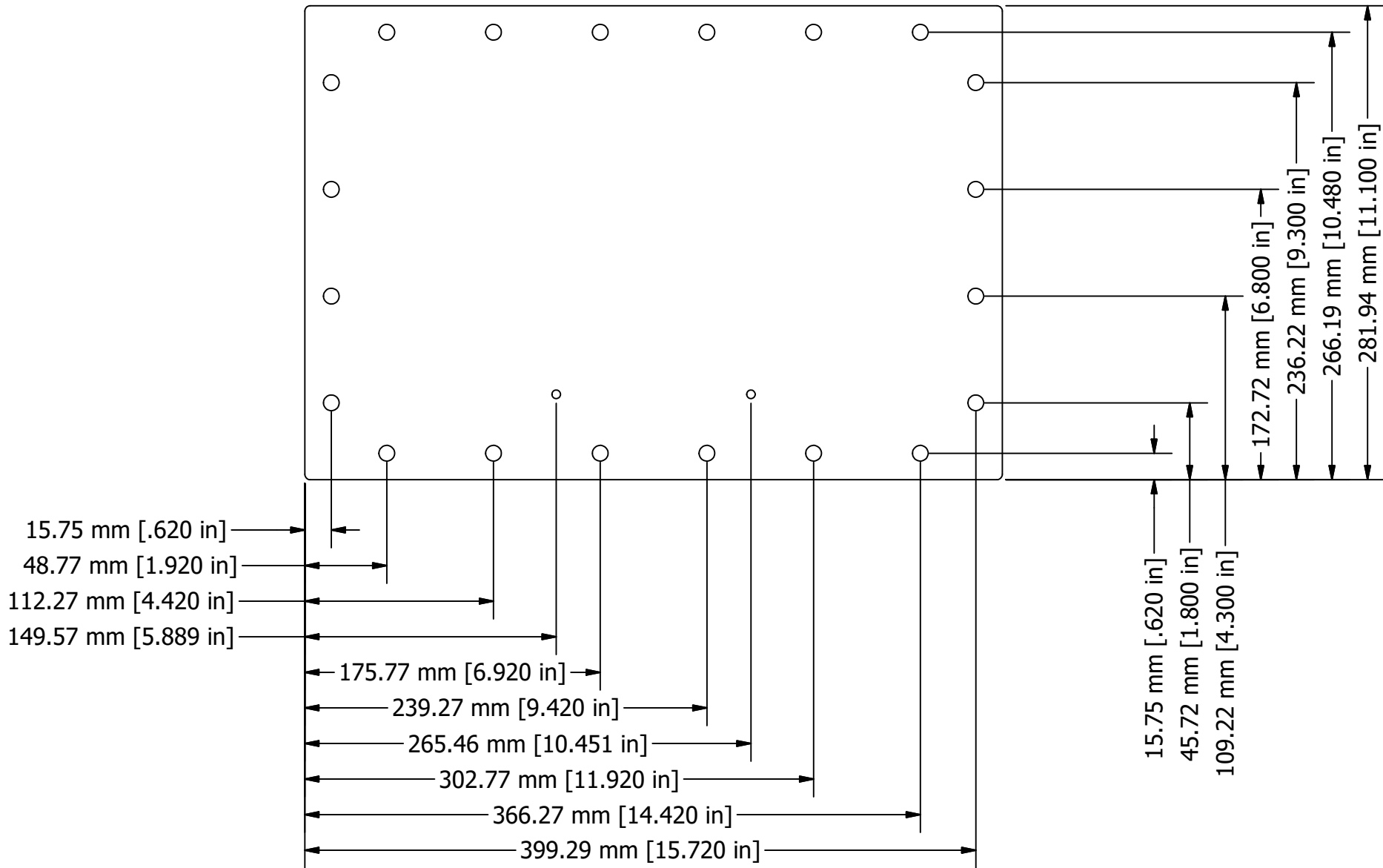

COMMENTS / NOTES

Front Panel of Enclosure



WWW.MACPANEL.COM

DRAWN BY
davecooper

DATE
16/04/2015

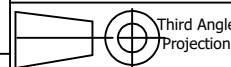

Third Angle
Projection

DESCRIPTION

Enclosure, ITA, JSF, EMI Shielded

SHEET
4 OF 5

DRAWING NO.

08701300FP14-CU

REVISION

H

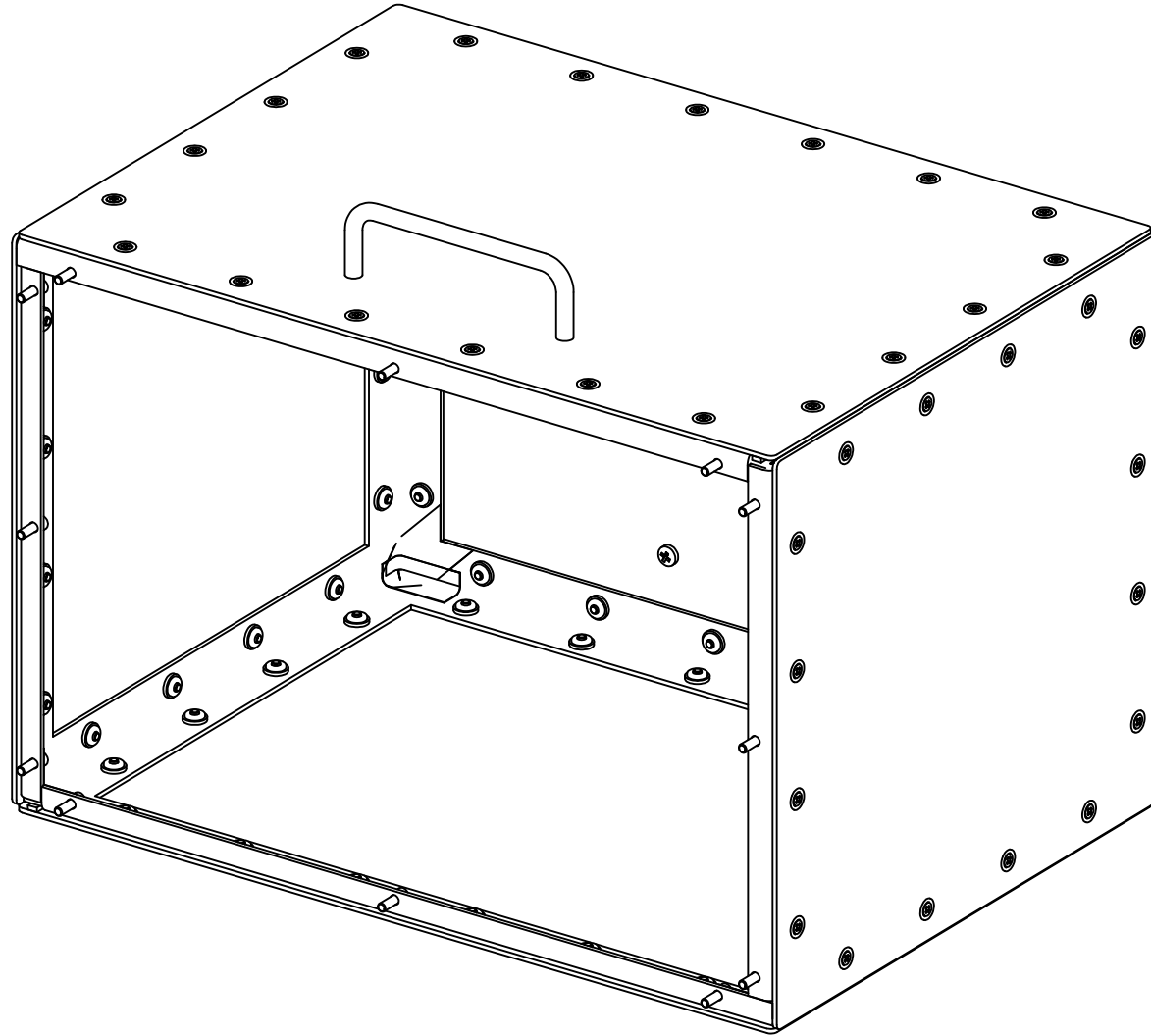

COMMENTS / NOTES

All Panels remove



WWW.MACPANEL.COM

DRAWN BY
davecooper

DATE
16/04/2015

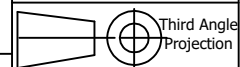

Third Angle
Projection

DESCRIPTION

Enclosure, ITA, JSF, EMI Shielded

DRAWING NO.

08701300-04-CU

REVISION

H

SHEET
5 OF 5